

# Pumpe med knivskær

Med sit effektive knivsystem findeler AGM dykumpen bl.a. foderrester og halm i din gylle. Pumpen arbejder med et tørstofindhold på op til 12%, ved en pH-værdi mellem 5 og 12. Max. væsketemperatur = 40° C. Kapslingsklasse = IP68.

Pumpen er både til vertikal og horisontal installation, og fås med forskellige former for installationstilbehør.

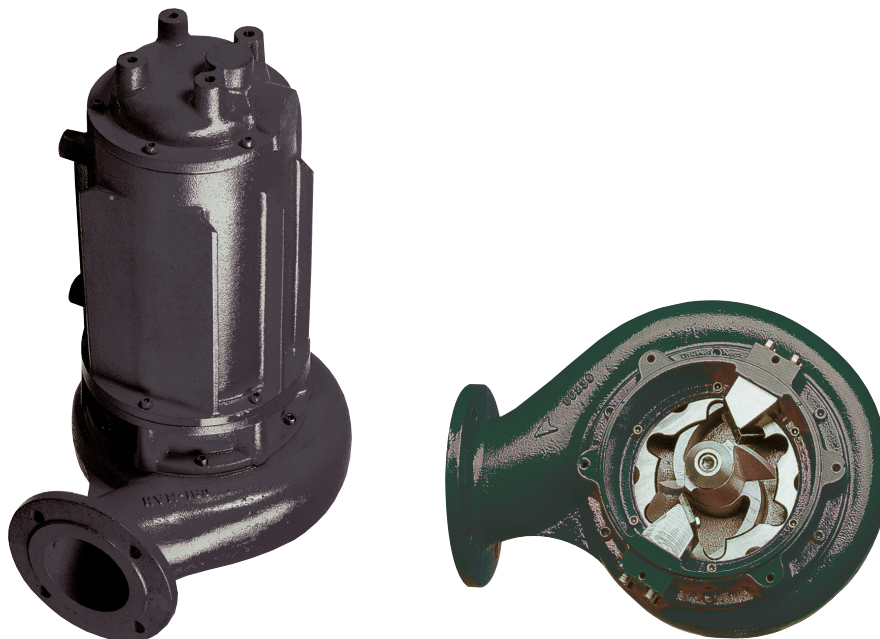

## AGM dykket knivskærspumpe

Varenr.	Betegnelse
2302PTS022080	2,2 kW pumpe, DN 80 flange PN 10
2302PTS030080	3 kW pumpe, DN 80 flange PN 10
2302PTS040080	4 kW pumpe, DN 80 flange PN 10
2302PTS1580	15 kW pumpe, DN 80 flange PN 10 - HØJTRYK
2302PTS18580	18,5 kW pumpe, DN 80 flange PN 10 - HØJTRYK
2302PTS040100	4 kW pumpe, DN 100 flange PN 10
2302PTS055100	5,5 kW pumpe, DN 100 flange PN 10
2302PTS075100	7,5 kW pumpe, DN 100 flange PN 10
2302PTS090100	9 kW pumpe, DN 100 flange PN 10
2302PTS110150	11 kW pumpe, DN 150 flange PN 10
2302PTS150150	15 kW pumpe, DN 150 flange PN 10
2302PTS185150	18,5 kW pumpe, DN 150 flange PN 10





#### Ydelsestabel for AGM dykket knivskærspumpe:

Pumpe	Effekt [kW]	l/sek. m³/time	0	10	15	20	25	30	40	50	60	70	80	90
			0	36	54	72	90	108	144	180	216	252	288	324
PTS 2.2 - 80	2,2	Løft mvs.	10,5	9,2	8,1	6,8	5,1							
PTS 3 - 80	3		12,8	11,3	10,4	9,1	7,4	5,3						
PTS 4 - 80	4		15,6	14,1	13	11,7	10	8						
PTS 15 - 80	15		41,5	36,7	34,2	31,2	28,2	25,1						
PTS 18.5 - 80	18,5		46,4	41,9	39,4	36,5	33,5	30,4	24,1					
PTS 4 - 100	4		9,8	9,5	9	8,4	7,3	5,8	3,7					
PTS 5.5 - 100	5,5		12	11,6	11,2	10,6	9,7	8,3	3,7					
PTS 7.5 - 100	7,5		14,7	14,3	14	13,4	12,6	11,3	6,7					
PTS 9 - 100	9		16,1	15,7	15,4	14,9	14,1	12,7	8,7					
PTS 11 - 150	11		15,2	14,7	14,4	14	13,7	13,3	12,3	11,1	9,4	7,1	4,2	
PTS 15 - 150	15		18,6	18,1	17,8	17,4	17	19,4	15,6	14,2	12,8	10,8	8	4,8
PTS 18.5 - 150	18,5		21,5	20,9	20,7	20,2	19,9	16,7	18,5	17,1	15,7	13,7	11	8

#### Tekniske data for AGM dykket knivskærspumpe:

Pumpe	Effekt [kW]	Spænding [V]	Fuldlaststrøm 400 V [A]	rpm	Kabel			Start		Vægt [kg]
					Antal	Dim.	Lgd. [m]	Direkte	*▲	
PTS 2.2 - 80	2,2	230-400	5,3	1450	1	9 x 1,5 mm²	8	*	*▲	73
PTS 3 - 80	3		6,8							75
PTS 4 - 80	4		9,1							76
PTS 15 - 80	15	400-690	31,2	2900	1	9 x 4 mm²	8	▲	*▲	200
PTS 18.5 - 80	18,5		36,5							210
PTS 4 - 100	4		9,1	1450		9 x 1,5 mm²				87
PTS 5.5 - 100	5,5		12,5			9 x 2,5 mm²				121
PTS 7.5 - 100	7,5		15,8			127				
PTS 9 - 100	9		19			132				
PTS 11 - 150	11		23,5			206				
PTS 15 - 150	15		30			219				
PTS 18.5 - 150	18		36			225				

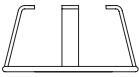
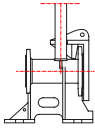
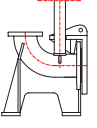
#### Dimensionering af konsol, fod og hejs:

Pumpe				
PTS 2.2 - 80 ..... PTS 18.5 - 80	TSV fod	FCH glidekobl.	FCV glidekobl.	PVT hejs
PTS 2.2 - 80 ..... PTS 18.5 - 80	TSV 80	FCH 80-80	FCV 80-80	PVT 80
PTS 4 - 100 ..... PTS 9 - 100	TSV 100	FCH 100-100	FCV 100-100	PVT 100
PTS 11 - 150 ..... PTS 18.5 - 150	TSV 150	FCH 150-150	FCV 150-150	PVT 150

# Kontrolpanel

- 400 V.
- 2 x niveau kontrol (min/max)
- Manuelt eller automatisk vælger
- Gear lys indikator
- Temperatur stop lys
- 24 V. AC
- Hovedafbryder
- Termisk relæ og fjernbetjening
- Konstrueret med SIEMENS komponenter



## Kontrolpanel

### DIREKTE STARTER

Varenr.	Type	Motor (kW)	IP-klassifikation
2302QUAD22	QUAD 2,2 - IP65	2,2	IP65
2302QUAD3	QUAD 3,0 - IP65	3	IP65
2302QUAD4	QUAD 4,0 - IP65	4	IP65
2302QUAD55	QUAD 5,5 - IP65	4,5	IP65
2302QUAD75	QUAD 7,5 - IP65	7,5	IP65

### STJERNE-TREKANT STARTER

Varenr.	Type	Motor (kW)	IP-klassifikation
2302QUST090	QUST 9 - IP65	9	IP65
2302QUST110	QUST 11 - IP65	11	IP65
2302QUST150	QUST 15 - IP65	15	IP65
2302QUST185	QUST 18,5 - IP65	18,5	IP65

# Tilbehør

## AGM dykket pumpe



Varenr.	Betegnelse
2302TSV080	TSV 80 lodret fod, galvaniseret
2302TSV100	TSV 100 lodret fod, galvaniseret
2302TSV150	TSV 150 lodret fod, galvaniseret
2302PV080	PV 80 hejs topmonteret
2302PV100	PV 100 hejs topmonteret
2302PV150	PV 150 hejs topmonteret
23637330	AGM kran
23637392	Lagertankbeslag med udvendig forankring for AGM kran
2302FCH080080	FCH 80-80 glidekobling
2302FCH100100	FCH 100-100 glidekobling
2302FCH150150	FCH 150-150 glidekobling
2302FCV080080	FCV 80-80 glidekobling
2302FCV080080-KPL	FCV 80-80 glidekobling incl. topmontering
2302FCV100100	FCV 100-100 glidekobling
2302FCV150200	FCV 150-200 glidekobling
13300035	2" galvaniseret guiderør - pris pr. meter
	<b>Kabelafastning - fastgørelse af kabel til sikkerhedskæde.</b> <b>Bruger 1 stk. pr. 80 cm eller 5 stk. til en 6 m tank.</b>
2302FC16	Til pumpestørrelse fra 2,2 kW - 4 kW
2302FC20	Til pumpestørrelse fra 5,5 kW - 9 kW
2302FC26	Til pumpestørrelse fra 11 kW - 18,5 kW

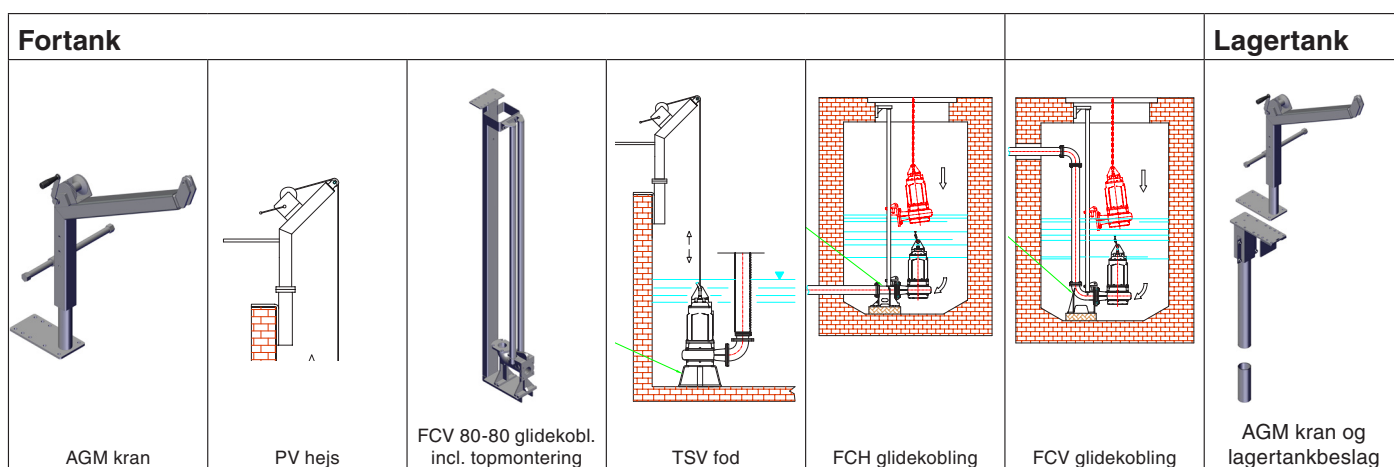



**Agrometer a/s**

Fælledvej 10  
7200 Grindsted  
Danmark

agrometer@agrometer.dk  
www.agrometer.dk  
CVR: 82942513